



MICROINVERTER

EVT360



**Zhejiang Envertech Corporation Ltd.**

Tel: +86 579 8926 6326

Web: [www.envertec.com](http://www.envertec.com)

Email: [info@envertec.com](mailto:info@envertec.com)

Add: 24th Floor, Jintong Mansion,  
Center of Headquarters, Yongkang City,  
Zhejiang Province, China

**User Manual**

[www.envertec.com](http://www.envertec.com)

# Content

1.	<b>Important Safety Information</b> .....	1
1.1	Read it First.....	1
1.2	Safety Instructions.....	1
2.	<b>Envertech Microinverter System</b> .....	2
2.1	How it Works.....	3
2.2	Monitoring Device: EnverBridge.....	3
2.3	Optimal Reliability.....	3
2.4	Simple Design.....	4
3.	<b>Product Information</b> .....	4
3.1	Overview.....	4
3.2	Major Characteristics.....	4
3.3	Datasheet.....	5
4.	<b>Packing checklist</b> .....	5
4.1	Accessories.....	5
4.2	Product Description.....	6
4.3	Further information.....	6
5.	<b>Planning of Microinverter Installation</b> .....	6
5.1	Symbols on Inverter.....	6
5.2	Accessories.....	7
5.3	Connection Method.....	7
6.	<b>Microinverter Installation</b> .....	8
7.	<b>Debugging and Operating</b> .....	14
7.1	Energize the System.....	14
7.2	EVT360 Operation.....	14
8.	<b>Troubleshooting and Maintenance</b> .....	14
8.1	LED Status Indications and Error Reporting.....	15
8.2	Troubleshoot an Inoperable Microinverter.....	15
8.3	Disconnect Microinverters from PV Modules.....	16
9.	<b>System Diagram</b> .....	17
10.	<b>Recycling and disposal</b> .....	18
11.	<b>Contact</b> .....	18

---

## 1. Important Safety Information

### 1.1 Read it First

This manual contains important instructions for installation and maintenance of the EVT360 microinverter.

To reduce the risk of electrical shock, and to ensure safe installation and operation of the microinverter, the following safety symbols appear throughout this document to indicate dangerous conditions and important safety instructions.



#### DANGER

DANGER indicates a hazardous situation which, if not avoided, will result in death or serious injury.



#### WARNING

WARNING indicates a hazardous situation which, if not avoided, can result in death or serious injury or moderate injury.



#### NOTICE

NOTICE indicates a situation that can result in property damage, if not avoided.

### 1.2 Safety Instructions

- Do not use Envertech equipment in a manner not specified by the manufacturer. Doing so may cause death or injury to persons, or damage to equipment.
- Be aware that only qualified personnel should install or replace the Envertech microinverters and the Cable and accessories.
- Do not attempt to repair the Envertech microinverter; it contains no user-serviceable parts. If it fails, contact Envertech customer service to start the replacement process. Tampering with or opening the Envertech microinverter will void the warranty.
- If the AC cable on the microinverter is damaged or broken, do not install the unit.
- Before installing or using the Envertech microinverter, read all instructions and cautionary markings in the technical description and on the Envertech microinverter system and the PV equipment.

- Connect the Envertech microinverter to the utility grid only after you have completed all installation procedures and receiving approval from the electric utility company.
- Please be kindly noted that the Envertech microinverter itself is a heat sink. Under normal operating conditions, its temperature is 20°C above ambient, but under extreme conditions the microinverter can reach a temperature of 80°C.

Do not disconnect the PV module from the Envertech microinverter without firstly disconnecting AC power.

## 2. Envertech Microinverter System

The Envertech microinverter system is an on-grid microinverter system with world top-class technology. This manual gave details about safe installation and operation of the Envertech Microinverter.

The three key elements of an Envertech microinverter system include :

- EVT360 microinverter: Converting the DC of the PV module into AC



- EnverBridge: monitoring and protecting PV system.



- EnverPortal: <http://www.envertecportal.com>



EnverView: IOS, Android App

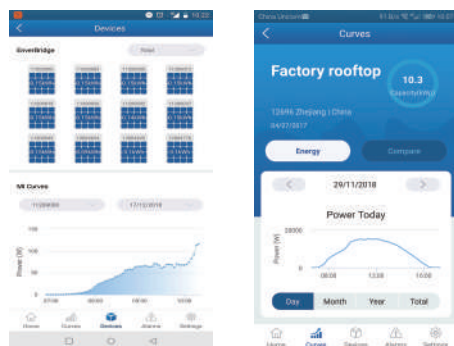

You can view the realtime data from a web browser or Envertech app. This integrated solar system maximizes energy harvest, increases system reliability, and simplifies design, installation and management.

#### 2.1 How it Works

The Envertech microinverter maximizes energy production from your photovoltaic (PV) array. Each Envertech microinverter is individually connected to one PV module in your array. This unique configuration means that an individual Maximum Peak Power Point Tracker (MPPT) controls each PV module. This ensures that the maximum power available from each PV module is exported to the utility grid regardless of the performance of the other PV modules in the array. That is, although individual PV modules in the array may be affected by shading, soiling, orientation, or PV module mismatch, the Envertech microinverter ensures top performance for its associated PV module. The result is maximum energy production from your PV system.

#### 2.2 Monitoring Device: EnverBridge

Once you install EnverBridge and have it connected to your broadband router or modem, Envertech microinverters automatically begin to report to EnverBridge' s server. EnverBridge monitoring system presents both realtime and history performance data.

#### 2.3 Optimal Reliability

Microinverter systems are inherently more reliable than traditional inverters. The distributed nature of a microinverter system ensures that there is no single point failure in the PV system. Envertech Microinverters are designed to operate at full power at ambient temperatures as high as +65°C(150°F). The microinverter casing is designed for outdoor installation and complies with the IP67 protection level.

NOTE: To ensure optimal reliability and to meet warranty requirements, the EVT360 microinverter must be installed according to the instructions in this manual.

#### 2.4 Simple Design

PV systems using Envertech microinverters are very simple to design and install. You can install a combination of PV modules of any type, at any orientation and in any quantity. You won' t need to install cumbersome traditional inverters. Each microinverter can be quickly mounted on the PV rack, directly beneath each PV module. Low voltage DC wires connect from the PV module directly to the co-located microinverter, eliminating the risk of personnel exposure to dangerously high DC voltage.

### 3.Product Information

#### 3.1 Overview



#### 3.2 Major Characteristics

Envertech microinverters have the following characteristics which make Envertech microinverters "Highly Efficient, Highly Reliable, Highly Cost Effective" :

- Low DC input voltage.
- Wide MPPT voltage range ensures high yield under various weather conditions.
- High MPPT accuracy ensures minimum power loss during converting.
- Complete set of protective functions.

Also, the following protective functions are integrated into Envertech microinverters:

- Internal overvoltage/undervoltage protection
- Faulty grounding protection
- Grid monitoring
- Current monitoring in grounding
- DC current monitoring

EVT360 can be adapted to almost all 60-cell or 72-cell modules. Before installation, please check the parameters of the microinverters and modules to ensure that they are compatible.

3.3 Datasheet

Model	EVT360
<b>Input Data (DC)</b>	
Recommended input power range (W)	180W ~ 450W+
Max. DC input (Vdc)	60V
Isc PV (absolute Max.) (A)	15A
Operating range (Vdc)	16V-60V
Max. input current (A)	12A
Mppt Voltage range (Vdc)	22~48V
<b>Output Data (AC)</b>	
Normal Voltage (Vac)	220V/230V
Frequency (Hz)	50Hz/60Hz
Current (Max. continuous) (A)	1.63A
Power (Max. continuous) (W)	360 W
Power factor range	+/-0.90
Total Harmonic Distortion	<3%
Maximum units per branch	16 Units (12AWG Cable)
<b>Efficiency</b>	
Peak inverter efficiency	95.6%
EURO weighted efficiency	95%
MPPT efficiency	99.9%
Nighttime power consumption	<100 mW
<b>Features</b>	
Communication	PLCC(Power Line Carrier Communication)
Compliance	VDE-AR-N 4105, IEC/EN61000, IEC/EN62109-1/2, EN50549-1/2019, TOR 2019, C10/11:2019, UTE C15-712-1:2013, VFR 2019
Warranty	15 Years
<b>Others</b>	
Ingress protection (IP)	IP 67
Protective class	Class I
Temperature(°C)	-40°C to +65°C
Relative humidity	0% ~ 98%
Overvoltage category	OVC III (AC Main), OVC II ( PV)
Inverter Isolation	<input checked="" type="checkbox"/> High Frequency Isolated
Weight	1.8kg
Dimensions	163 mm x 216 mm x 27 mm

4.Packing checklist

4.1 Accessories

After you receive the Envertech microinverter, please check if there is any damage on the carton, and then check the inside completeness for any visible external damage on the microinverter and accessories. Contact your dealer if anything is damaged or missing.

4.2 Product Description

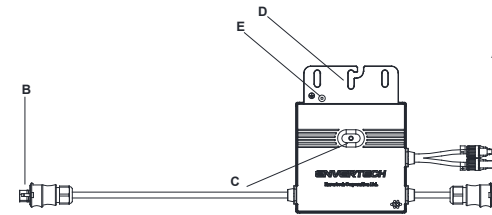

Item	Description
A	DC connectors
B	AC connector
C	LED light
D	Wall bracket hole
E	Grounding hole

4.3 Further information



If you have any further questions concerning accessories or installation, please check our website [www.envertec.com](http://www.envertec.com) or send an email to [tech@envertec.com](mailto:tech@envertec.com).

5.Planning of Microinverter Installation

5.1 Symbols on Inverter

Symbol	Description
	Dangerous electrical voltage This device is directly connected to public grid, thus all work related to the inverter shall only be carried out by qualified personnel.
	NOTICE, danger! This device directly connected with electricity generators and public grid.
	Danger of hot surface The components inside the inverter will release a log of heat during operation. DO NOT touch aluminum casing during operating.
	An error has occurred Please go to Chapter 10 "Trouble Shooting" to repair the error.
	This device SHALL NOT be disposed of in residential waste. Please go to Chapter 9 "Recycling and Disposal" for proper treatments.
	No unauthorized perforations or modifications Any unauthorized perforations or modifications are strictly forbidden. If any defect or damage (device/person) is occurred, Envertech shall not take any responsibility for it.

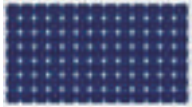
5.2 Accessories

PV Modules	60-cell / 72-cell module	
AC extension cable (AWG12 or above)	To connect the AC side to the grid. Three-wire cable: AWG12 or above.	
AC End Cap	To seal the end of unused AC cable.	

5.3 Cable Model Selection

To install the AC Bus Cable, you just simply unroll the cable to the needed length to make the cut. Directly connect the AC Bus Cable to the junction box of the branch. Seal the other cutting end with the end cap to make it isolated from the environment. You should choose the type of AC Bus Cable according to the orientation of PV module. We suggest the following type of cable:

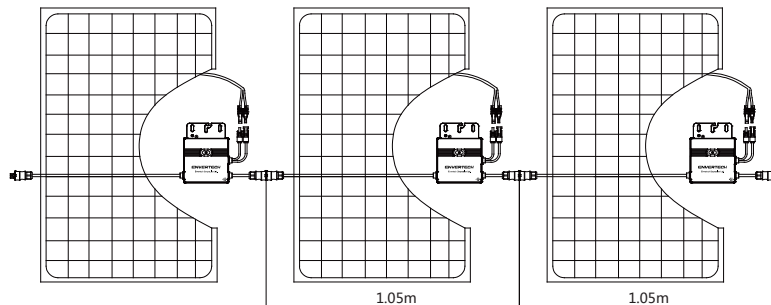

6. Microinverter System Installation



**WARNING**

Installation could only be implemented when the system is disconnected from the grid, and the solar panel has been covered or disconnected.

1. Mount microinverters onto the rack  
Mark out the estimated center of each PV module on the rack to facilitate locating microinverters. Mount all microinverters under modules to avoid rain and sun, with the trademark facing downward.

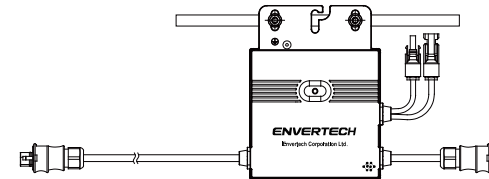

Please make sure that there are less than 8 units of EVT360 in each branch (12AWG).

2. Grounding  
Microinverters and modules must be connected to the grounding conductor in accordance with national standards.  
Fix the grounding wire with screws to the microinverter's grounding hole, so that the grounding of microinverters can be realized.

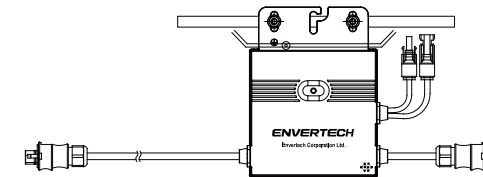

3. Connect microinverter AC cables serially  
Connect the AC connectors on both sides of microinverters in a hand-in-hand way.

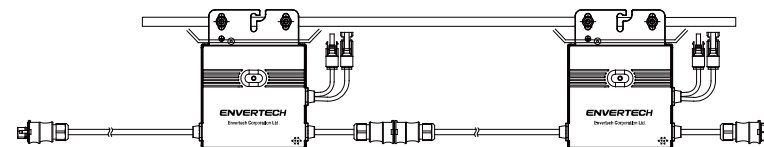

4. Fasten AC cables

Fasten AC cables and grounding cables to the rack with cable ties.

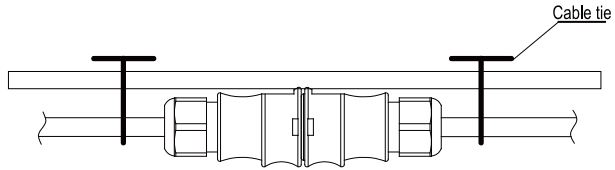

5. Seal the unused connector of AC cable

Insert the end cap directly into the connector on the unused end, and check if it is inserted in place.

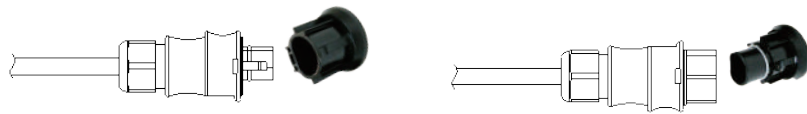

6. Connect AC cable to the junction box

Connect AC cable to the input of the junction box.

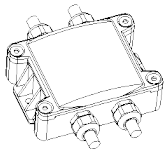

7. Mount EnverBridge

Take out the power cord and connect it to the EVB300, Screw on the antenna. Wait 3 minutes till the EVB300 green light blink, you can start the operation after booting EVB300.

Option 1: Ethernet Mode

- (1) Fix EVB300 at proper position in or close to the distribution box;
- (2) Run the RJ45 cable and connect the EVB300 to your router;
- (3) Put the EVB300 plug into the socket.

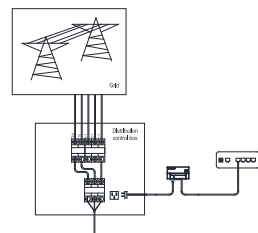

Option 2: Wireless mode

- (1) Fix EVB300 at proper position in or close to the distribution box within the range Wi-Fi signal.
- (2) Turn off the air switch and connect EVB300's power cable to the air switch.

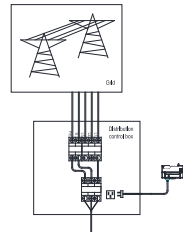

Wi-Fi configuration setting

a) Connect network whose name is same as your monitor's SN in your cellphone.

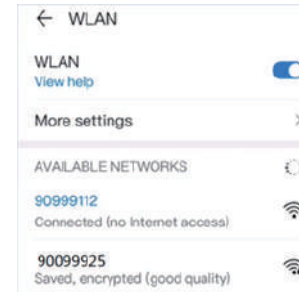

b) Open EnverView and click Wi-Fi Setting.

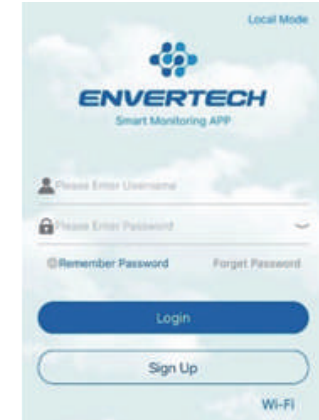

c) Click the magnifying glass icon.

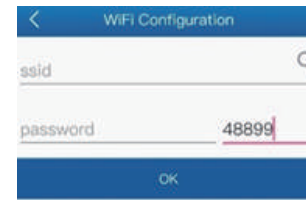

d) Select the Wi-Fi monitor need to connect. Enter the password, finally click the OK button.



Step 8: Prepare AC extension cable

- (1) Remove the skin of the two ends of the extension cable by  $y=40\text{mm}$  and remove the skin of internal wires by  $x=14\text{mm}$ . Set the metal terminals onto the open parts and clamp them to tighten the connection;
- (2) Connect one side of the extension cable to the junction box;
- (3) Connect the other side of the extension cable to the air switch.

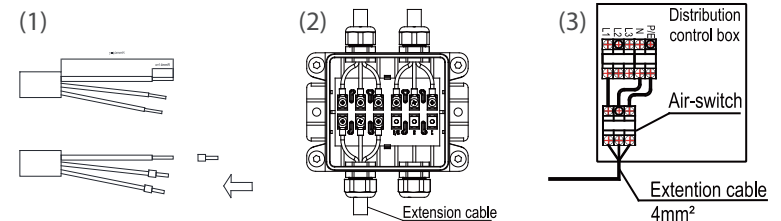

Step 9: Connect PV modules to microinverters

Mount the PV modules on top of microinverters;

Connect each PV module with the DC input cables of the microinverter.

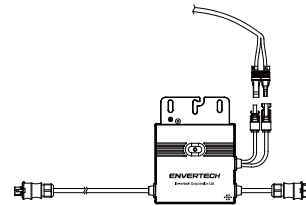

Step 10: Switch on the PV system

Ensure all connection is completed and then turn on the air switch.

Step 11: Monitoring through EnverPortal

1) Register a new account. Visit [www.envertechportal.com](http://www.envertechportal.com). Click Sign Up. Fill in the account information to finish registration.



2) EVB202 MI Binding

**Option 1. Use Enverview app to bind MI**

Step 1: Login your account on your mobile phone. Then go to "Settings".

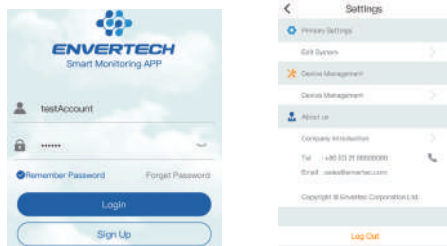

Step 2: Under "Device Management", click "Add" and enter MI SN manually or click the QR Code icon on the right to scan the MI SN automatically.



Step 3: Click "Confirm" to finish adding the MI.

Note: Please ensure that both EVB300 and your phone are in same router network.

**Option 2. Use EnverView app to bind MI (Local model)**

Note: Please ensure that both EVB300 and your phone are in same router network.

Step 1: Launch EnverView app, enter Local Mode. Connect your EVB300.

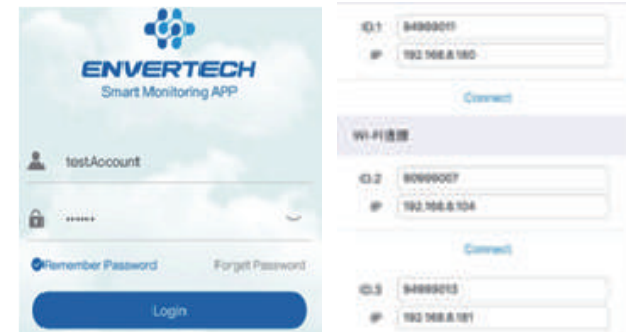

Step 2: On EVB Overview page, enter Settings. Click Add MI you could choose enter MI SN manually or click the grid icon to scan the MI SN automatically.

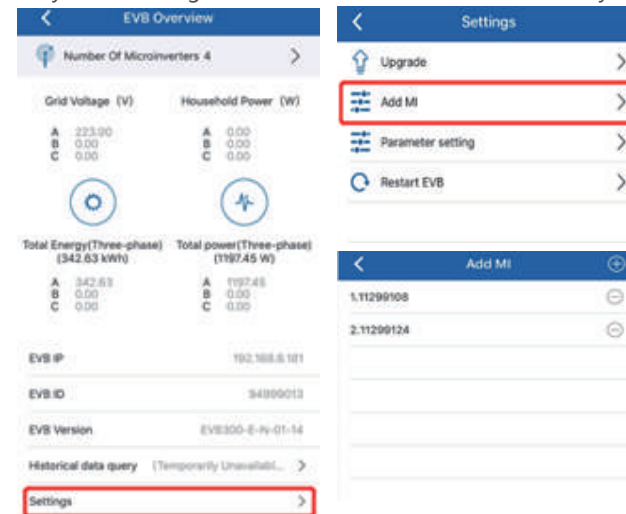



Or you can scan the bar code.

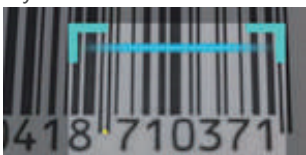

Step 3: Click confirm to finish Adding MI.

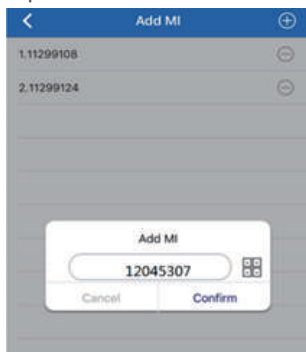

**Option 3. Use Envertecportal to add MI**

Step 1: Login [www.envertecportal.com](http://www.envertecportal.com) with the newly-registered account, go to "Settings—Management" .



Step 2: Click Add, then enter the SN of Monitor, click OK to finish adding monitor. Click "+" button behind the Monitor SN, then enter the SN of microinverter, click OK to finish binding.

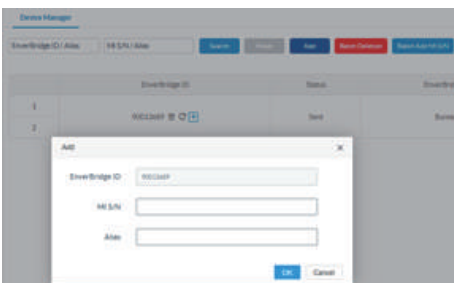

**7. Debugging and Operating**

Please notice the symbols.



**WARNING**

Only qualified personnel may connect the Envertech microinverter to the utility grid after receiving prior approval from the electrical utility company.



**WARNING**

Ensure that all AC and DC wiring is correct. Ensure that none of the AC and DC wires is twisted or damaged.

**7.1 Energize the System**

1. Turn on the switch or the circuit breaker at each microinverter AC branch.
2. Turn on the main AC circuit breaker in the distribution box. Your system will start to produce power after 3 minutes.
3. Envertech microinverters begin to communicate through the power lines to EnverBridge. The entire system will be detected within 10 minutes.
4. The voltage and frequency of EVT360 can be adjusted on the site. If adjustments are required by your local utility company, installers can use EnverBridge to manage grid parameters after all microinverters have been detected.

**7.2 EVT360 Operation**

The Envertech microinverter is powered on when there is sufficient DC voltage from the PV module. The LED light of each microinverter will blink green to indicate normal start-up operation approximately 1 minute after DC power is applied.

**8. Troubleshooting and Maintenance**

Adhere to all the safety measures described throughout this manual. If the PV system does not operate correctly, the following troubleshooting measures can be applied by qualified personnel.



**WARNING**

Do not attempt to repair the Envertech microinverter. It contains no user-serviceable parts. If the microinverter fails, contact your direct supplier or Envertech customer service to obtain an RMA (return merchandise authorization) number and start the replacement process.

8.1 LED Status Indications and Error Report

**LED Startup:**

The LED of each microinverter blinks red for a while at the beginning, and then blinks green to indicate normal start-up approximately 10 seconds after DC power is applied. If the LED blinks red after DC power is on, it indicates a failure during the start-up.

**Post-Startup LED Indications:**

Check LED status to confirm the present situation.

**Flashing Green: It indicates normal operation.**

**Flashing Red:**

1. If red light flashes every 2 or 3 seconds, it indicates that the microinverter is waiting for sun or prepare to produce energy.
2. If red light flashes continuously, it indicates that the microinverter is not operating normally. The microinverter does not detect that the utility grid is within operable voltage/frequency range. The microinverter cannot produce power until this is solved.

8.2 Troubleshoot an Inoperable Microinverter

To troubleshoot an inoperable microinverter, follow the steps in the order shown below.

**WARNING:** Be aware that only qualified personnel should troubleshoot the PV array or the Envertech microinverter.

*Best Practice:* Please do not disconnect DC connection while the system is working. Ensure that no current is flowing in the DC wires prior to disconnecting. If necessary, use an opaqueto cover the PV module prior to disconnecting the PV module. Always disconnect AC power before disconnecting the PV module from the Envertech microinverter. Disconnecting AC connectors of the microinverters is also a means of cutting off AC power.

**WARNING:** The AC and DC connectors on the cabling are rated as a disconnecting point only when used with an Envertech microinverter.

**WARNING:** Envertech microinverters are powered by DC power from the PV modules. Please disconnect and reconnect DC power to check the LED blinks 1 minute after DC is applied.

1. Make sure AC breakers are on.
2. Check the connection to the utility grid and verify that the grid voltage is within allowable ranges shown in the Technical Data section.
3. Verify that AC voltage at all solar power circuit breakers of the load centers are within the ranges shown in the following table.
4. Verify that AC line voltage at the junction box for each AC branch circuit is within the ranges required by local grid standards.

Single-Phase 230 VAC		Three-Phase 230 VAC	
L to N	180 to 265VAC	L1 to L2 to L3	310 to 460VAC

5. Confirm if the microinverter side is connected to the grid by measuring the voltage from AC line to line and line to neutral.
6. Visually check if AC branch circuit connection is correctly done. Reinstall if necessary.- Check also for damage, such as rodent damage.
7. Make sure that all circuit breakers are off.
8. Disconnect and re-connect the PV modules' DC connectors with microinverters. The LED status of each microinverter will blink green to indicate normal start-up operation soon after DC power is applied (less than one minute).
9. Attach an ammeter clamp to one conducting wire of the DC cables from the PV module to measure the microinverter's current. This will be under 1 Amp if AC is disconnected.
10. Check the DC connection between the microinverter and the PV module. The connection may need to be tightened or reseated. If the connection is worn out or damaged, it needs replacement.
11. Verify with your utility company that grid frequency is within the regulated range.

8.3 Disconnect Microinverters from PV Modules

If your problems are still unsolved with the steps above, please contact Envertech tech support through [www.envertec.com](http://www.envertec.com). If Envertech approves the replacement, please take off the microinverter according to the following instructions. In order to ensure the disconnection between the microinverter and the PV Module will not be done while the microinverter is at working status, please strictly follow the steps below.

1. Turn off AC branch circuit breaker.
2. Disconnect the microinverters in the following procedure:  
Pull the AC connectors of both sides of the microinverters in the opposite direction with appropriate force.

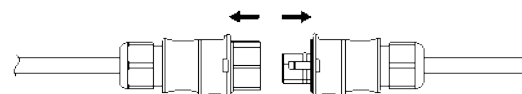

3. Cover the PV module with an opaque, and then disconnect the PV module DC connectors from the microinverter.
4. Loosen the grounding screw and remove the grounding wire.
5. Take off the microinverter from the PV frame.

### 9. System Diagram

(1) Single phase:

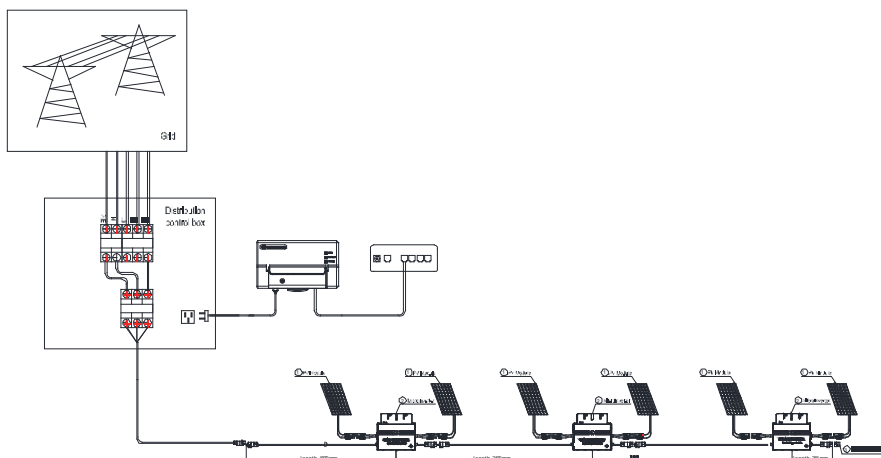

(2) Three phase:

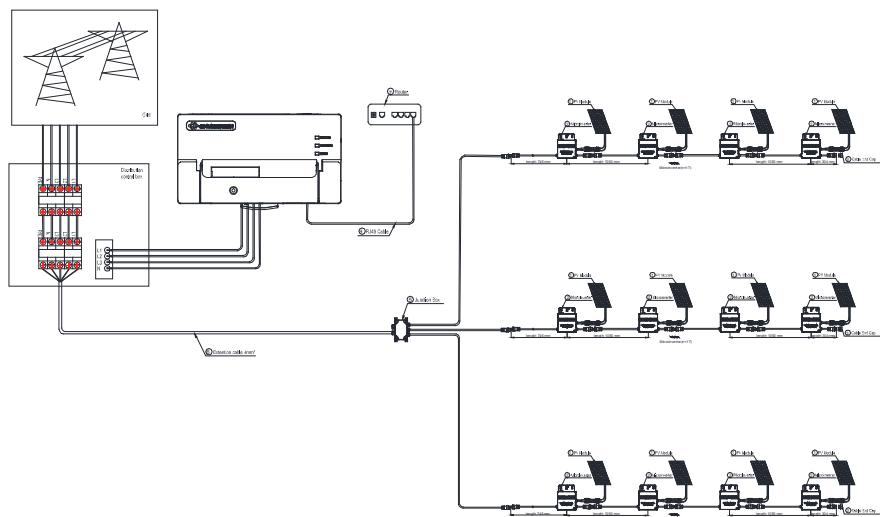

Unscrew the front cover with the complimentary hex screwdriver, then plug wires on each phase into the corresponding connector of EVB300.

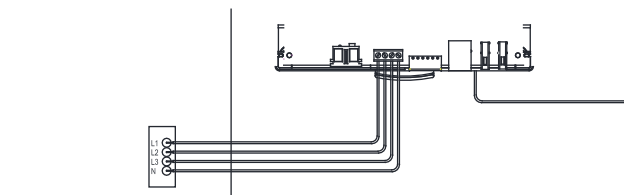

### 10. Recycling and disposal

	<p><b>WARNING</b> This device cannot be disposed in a household trash can.</p>
--	--

In order to comply with the regulations on recycling management of electrical and electronic wastes in various countries, electrical equipments that have reached its lifetime must be collected separately to the unit or individual that has obtained the qualification for disposing discarded electrical and electronic products. For any equipment that you no longer use, please return it to your dealer for recycling, or send it to an approved recycling unit in your area for recycling.

### 11. Contact

**Zhejiang Envertech Corporation Ltd.**

**Tel:** +86 579 8926 6326 **Web:** [www.envertec.com](http://www.envertec.com) **Email:** [info@envertec.com](mailto:info@envertec.com)  
**Add:** 24th Floor, Jintong Mansion, Center of Headquarters, Yongkang City, Zhejiang Province, China